

ZOTAC[®]

INTEL SERIES MOTHERBOARD



Designed for 2nd generation Intel[®]
Core i3, i5, i7 and Pentium[®] Processors

H6 1TX SERIES MOTHERBOARD
USER'S MANUAL



Electronic Emission Notices

Federal Communications Commission (FCC) Statement

This equipment has been tested and found to comply with the limits for a Class B digital device, pursuant to Part 15 of FCC Rules. These limits are designed to provide reasonable protection against harmful interference in a residential installation. This equipment generates, uses and can radiate radio frequency energy and, if not installed and used in accordance with instructions contained in this manual, may cause harmful interference to radio and television communications. However, there is no guarantee that interference will not occur in a particular installation.

If this equipment does cause harmful interference to radio or television reception, which can be determined by turning the equipment off and on, the user is encouraged to try to correct the interference by one or more of the following measures:

- REORIENT OR RELOCATE THE RECEIVING ANTENNA
- INCREASE THE SEPARATION BETWEEN THE EQUIPMENT AND THE RECEIVER
- CONNECT THE EQUIPMENT INTO AN OUTLET ON A CIRCUIT DIFFERENT FROM THAT OF THE RECEIVER
- CONSULT THE DEALER OR AN EXPERIENCED AUDIO/TELEVISION TECHNICIAN

NOTE:

Connecting this device to peripheral devices that do not comply with Class B requirements, or using an unshielded peripheral data cable, could also result in harmful interference to radio or television reception.

The user is cautioned that any changes or modifications not expressly approved by the party responsible for compliance could void the user's authority to operate this equipment.

To ensure that the use of this product does not contribute to interference, it is necessary to use shielded I/O cables.

Copyright

This manual is copyrighted with all rights reserved. No portion of this manual may be copied or reproduced by any means.

While every precaution has been taken in the preparation of this manual, no responsibility for errors or omissions is assumed. Neither is any liability assumed for damages resulting from the use of the information contained herein.

Trademarks

All brand names, logos and registered trademarks mentioned are property of their respective owners.

CAUTION:

Risk of explosion if the battery is replaced with an incorrect type. Batteries should be recycled where possible. Disposal of used batteries must be in accordance with local environmental regulations.

Table of Contents

Motherboard Specifications	4
Motherboard Layout	6
Hardware Installation	9
Safety Instructions	9
Preparing the Motherboard	10
Installing the CPU	10
Installing the CPU Fan	11
Installing Memory Modules	11
Installing the Motherboard	12
Installing the I/O Shield	12
Securing the Motherboard into the Chassis	12
Connecting Cables and Setting Switches	13
24-pin ATX Power Connector-PW1	14
4-pin ATX_12V power connector-PW2	14
SPDIF-Out Header-CN5	15
COM Header-CN4 (Optional)	15
Front panel header-FP1	15
USB Headers-FP_U1/2/FP_USB3_1	16
Front Panel Audio Header-FP_S1	16
Speaker Header-SPK1	17
Serial-ATA (SATA) Connectors (SATA1/2/5)	17
Fan Connectors	17
Expansion Slots	18
Jumper Settings	18
Configuring the BIOS	19
Enter BIOS Setup	19
Main Menu	19
Advanced Menu	20
X-Setting	20
H/W Monitor	20
Storage Configuration	21
CPU Configuration	21
USB Configuration	21
Super IO Configuration	22
ACPI Settings	22
Chipset Menu	22
Display Configuration	22
OnBoard Device Config	23
Boot Menu	23

Boot Settings Configuration	23
Security Menu	24
Administrator Password	24
User Password.....	24
Exit Menu.....	25
Save Changes and Exit.....	25
Discard Changes and Exit	25
Save Changes and Reset.....	25
Discard Changes and Reset	25
Save Changes	25
Discard Changes.....	26
Restore Defaults.....	26
Save as User Defaults	26
Restore User Defaults	26
Launch EFI Shell from filesystem device	26
Flash Update Procedure	26
Installing Drivers and Software	27
Drivers Installation	27
Realtek HD Audio Driver Setup	37
Getting Started	37
Sound Effect	37
Mixer	39
Audio I/O.....	41
Microphone.....	45
3D Audio Demo	46
Information	46

Motherboard Specifications

Chipset

- ❖ Intel® H61 Chipset

Size

- ❖ Mini ITX form factor of 6.7 X 6.7 inch

Microprocessor support

- ❖ Supports LGA 1155 Socket for 2nd Generation Intel® Core i3/i5/i7 and Pentium processors

Operating systems

- ❖ Supports Windows XP 32bit/64bit, Windows Vista 32bit/64bit and Windows 7 32bit/64bit

System Memory

- ❖ Supports 1 GB, 2 GB, 4 GB and 8 GB DDR3 DRAM devices
- ❖ Supports Dual Channel DDR3 1066 and 1333 MT/s
- ❖ Maximum memory size: 16 GB

USB 2.0 ports

- ❖ Supports hot plug and play
- ❖ Eight USB 2.0 ports (four ports on the back panel, four via the USB brackets connected to the internal USB headers)
- ❖ Supports USB 2.0 protocol up to 480 Mbps transmission rate

USB 3.0 ports

- ❖ Supports hot plug and play
- ❖ Four USB 3.0 ports (two on the back panel, two via the USB bracket connected to the internal USB header)
- ❖ Fully backward compatible with USB 2.0 and 1.1 specifications

Onboard Serial ATA ports

- ❖ Independent DMA operation on three ports
- ❖ Three SATAII ports (3.0 Gb/s)

eSATA Port

- ❖ One eSATA port on backpanel
- ❖ Supports hot plug and play
- ❖ Provide a link for 3.0 Gb/s data speed

Onboard LAN

- ❖ Support Full Duplex flow control (IEEE802.3x)
- ❖ 10/100/1000 BASE-T IEEE 802.3 compliant

- ❖ Wake On LAN (WOL) power management support

WiFi support

- ❖ Compliant with IEEE802.11n Draft 2.0 Standard
- ❖ High speed wireless connection and enhanced wireless security
- ❖ Max transfer rate up to 300 Mbps or 150 Mbps (optional for different models)

Audio

- ❖ 8 channel High Definition Audio (including one optical SPDIF output port)
- ❖ All DACs support 192k/96k/48k/44.1kHz sample rate
- ❖ One SPDIF-out header on board

Green Function

- ❖ Support SMM, APM, ACPI
- ❖ Suspend to DRAM supported (STR)
- ❖ AC power failure recovery

Onboard Graphics Features

- ❖ Integrated GPU contains a refresh of the sixth generation graphics core
- ❖ DX10.1 and OpenGL 3.0 are supported
- ❖ 3D Graphics Rendering Enhancements
- ❖ HDMI/DP/DVI ports output support (DVI-VGA adaptor bundled in some model)
- ❖ Support resolution up to 1920x1200 @ 60Hz for HDMI/DVI and 2560x1600 @ 60Hz for DP

PCI Express Interface

- ❖ Supports PCI Express 2.0
- ❖ Wake up function is supported
- ❖ Clock spread spectrum capability

Expansion slots

- ❖ One PCI Express x16 slot
- ❖ One Mini PCI Express slot (full-height)

Motherboard Layout

Figure 1 shows the motherboard and Figure 2 shows the back panel connectors.

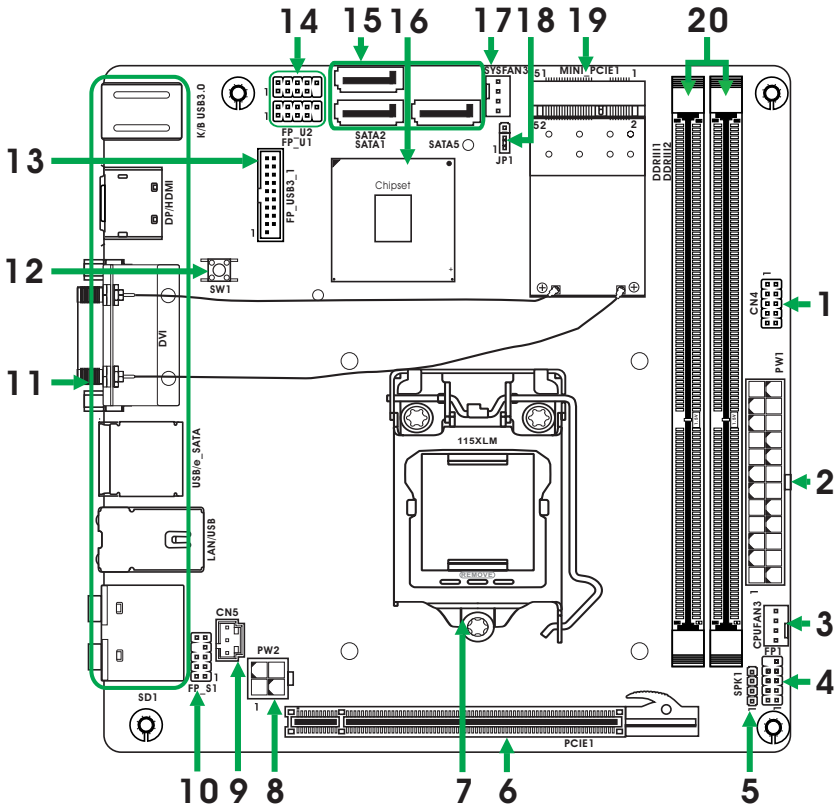
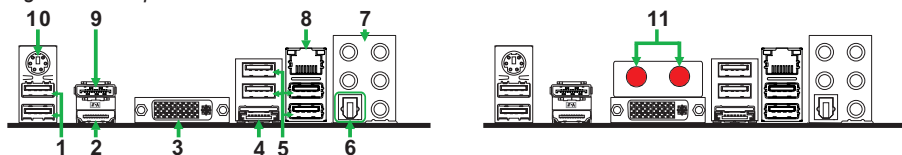

Figure 1

Figure 1. Board Layout

- | | |
|---|--|
| <ol style="list-style-type: none"> 1. COM Header-CN4 (Optional) 2. 24-pin ATX Power Connector-PW1 3. CPU Fan Connector-CPUFAN3 4. Front Panel Header-FP1 5. Speaker Header-SPK1 6. PCI Express x16 Slot-PCIE1 7. CPU Socket 8. 4-pin ATX 12V power connector-PW2 9. SPDIF-Out Header-CN5 10. Front Panel Audio Header-FP_S1 | <ol style="list-style-type: none"> 11. Backpanel Connectors 12. Clear CMOS Button-SW1 13. USB 3.0 Header-FP_USB3_1 14. USB 2.0 Headers (FP_U1-FP_U2) 15. Serial-ATA (SATA) Connectors (SATA1/2/5) 16. Chipset 17. SYS Fan Connector-SYSFAN3 18. Clear CMOS Jumper-JP1 19. Mini PCI Express Slot-MINI_PCIE1 20. DDRIII DIMM Sockets-DDRIII1~2 |
|---|--|

Figure 2. Backpanel connectors



1. USB 3.0 Ports
2. HDMI Port
3. DVI Port
4. eSATA Port
5. USB 2.0 Ports
6. Optical SPDIF Output

7. Port	2-Channel	4-Channel	6-Channel	8-Channel
Blue	Line-In	Line-In	Line-In	Side Speaker Out
Green	Line-Out	Front Speaker Out	Front Speaker Out	Front Speaker Out
Pink	Mic In	Mic In	Mic In	Mic In
Black	–	–	Center/Subwoofer	Center/Subwoofer
Orange	–	Rear Speaker Out	Rear Speaker Out	Rear Speaker Out

8. LAN port LED indicators

Speed LED Activity LED

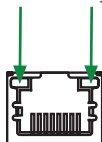

Speed LED

Status	Description
Off	Speed: 10 Mbps
Green	Speed: 100 Mbps
Orange	Speed: 1000 Mbps

Activity LED

Status	Description
Off	No link
Orange	Linked
Blinking	Data activity

9. DisplayPort
10. PS2 Keyboard/Mouse Port

11. WiFi antenna connectors (Optional)

This motherboard can support two WiFi antenna modules. Refer to the following to install the WiFi antenna modules.

Step 1. Remove the red caps from the WiFi antenna connectors.

Step 2. Install the WiFi antennas to the WiFi antenna connectors, and make sure the screws are rotated in clockwise direction.

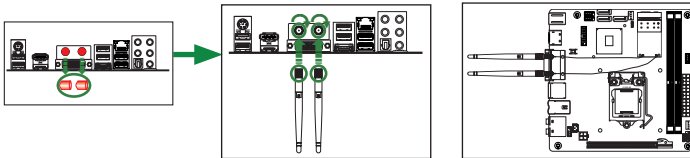

Note: 1. Users please note that the appearance of your WiFi antenna modules may not be exactly the same as those shown in this manual.

2. Users can install one or two WiFi antennas to the motherboard.

3. Users can bend or rotate the WiFi antennas to the best receiving direction according to the picture below.

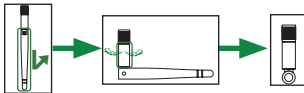

Hardware Installation

This section will guide you through the installation of the motherboard. The topics covered in this section are:

- Preparing the motherboard
 - ❖ Installing the CPU
 - ❖ Installing the CPU fan
 - ❖ Installing Memory DIMMs
- Installing the motherboard
- Connecting cables and setting switches

Safety Instructions

To reduce the risk of fire, electric shock, and injury, always follow basic safety precautions.

Remember to remove power from your computer by disconnecting the AC main source before removing or installing any equipment from/to the computer chassis.

Preparing the Motherboard

The motherboard shipped in the box does not contain a CPU or memory DIMM. You need to purchase them to complete this installation.

Installing the CPU

Be very careful when handling the CPU. Make sure not to bend or break any pins on the back. Hold the processor only by the edges and do not touch the bottom of the processor.

The following illustration shows CPU installation components

1. Unhook the socket lever by pushing down and away from the socket.
2. Lift the socket lever and the load plate to fully open position.
3. Use your thumb and forefinger to lift the cap up vertically.
 - Be careful not to touch the socket contacts.
4. Hold the processor with your thumb and forefinger. Insert the processor into the socket vertically.
 - Align the CPU pin 1 mark with the pin 1 corner of the CPU socket.
5. Make sure the CPU is fully seated, and then replace the load plate.
 - Be sure that the front end of the load plate is under the shoulder screw.
6. Secure the load lever to its locked location.

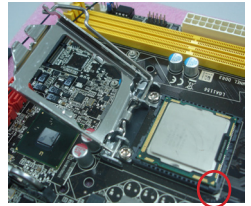
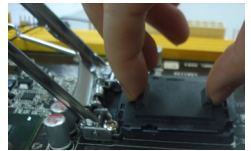

Installing the CPU Fan

There are many different fan types that can be used with this motherboard. Follow the instruction that came with your fan assembly. Be sure that the fan orientation is correct for your chassis type and your fan assembly.

Installing Memory Modules

Your new motherboard has two 1.5V 240-pin slots for DDR3 memory. These slots support 1 GB/2 GB/4 GB/8 GB DDR3 devices. There must be at least one memory bank populated to ensure normal operation. Refer to the following recommendations to install memory modules.

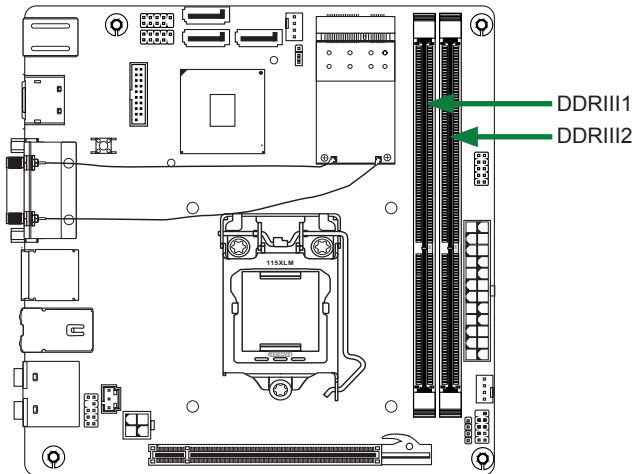

Note that a memory module has a notch, so it can only fit in one direction. Refer to the following procedure to install memory modules into the slots on the motherboard.

1. Unlock a DIMM slot by pressing the module clips outward.
2. Align the memory module to the DIMM slot, and insert the module vertically into the DIMM slot. The plastic clips at both sides of the DIMM slot automatically lock the DIMM into the connector.

Installing the Motherboard

The sequence of installing the motherboard into the chassis depends on the chassis you are using and if you are replacing an existing motherboard or working with an empty chassis. Determine if it would be easier to make all the connections prior to this step or to secure the motherboard and then make all the connections. It is normally easier to secure the motherboard first. Use the following procedure to install the I/O shield and secure the motherboard into the chassis.

Note: *Be sure that the CPU fan assembly has enough clearance for the chassis covers to lock into place and for the expansion cards. Also make sure the CPU Fan assembly is aligned with the vents on the covers.*

Installing the I/O Shield

The motherboard kit comes with an I/O shield that is used to block radio frequency transmissions, protects internal components from dust and foreign objects, and promotes correct airflow within the chassis.

Before installing the motherboard, install the I/O shield from the **inside** of the chassis. Press the I/O shield into place and make sure it fits securely. If the I/O shield does not fit into the chassis, you would need to obtain the proper size from the chassis supplier.

Securing the Motherboard into the Chassis

Most computer chassis have a base with mounting studs or spacers to allow the motherboard to be secured to the chassis and help to prevent short circuits. If there are studs that do not align with a mounting hole on the motherboard, it is recommended that you remove that stud to prevent the possibility of a short circuit. In most cases, it is recommended to secure the motherboard with spacers.

1. Carefully place the motherboard onto the studs/spacers located inside the chassis.
2. Align the mounting holes with the studs/spacers.
3. Align the connectors to the I/O shield.
4. Ensure that the fan assembly is aligned with the chassis vents according to the fan assembly instruction.
5. Secure the motherboard with screws.

Connecting Cables and Setting Switches

This section takes you through all the connectors and switch settings necessary on the motherboard. This will include:

- Power Connectors
 - ❖ 24-pin ATX Power Connector-PW1
 - ❖ 4-pin ATX_12V Power Connector-PW2
- Internal Headers/Connectors
 - ❖ SPDIF-Out Header-CN5
 - ❖ COM Header-CN4 (Optional)
 - ❖ Front Panel Header-FP1
 - ❖ USB Headers (FP_U1/2/FP_USB3-1)
 - ❖ Front Panel Audio Header-FP_S1
 - ❖ Speaker Header-SPK1
- Serial-ATA (SATA) Connectors (SATA1/2/5)
- Fan Connectors
- Expansion Slots
- CMOS Jumper Settings

See Figure 1 to locate the connectors and jumpers referenced in the following procedure.

24-pin ATX Power Connector-PW1

PW1 is the main power supply connector. Make sure that the power supply cable and pins are properly aligned with the connector on the motherboard. Firmly plug the power supply cable into the connector and make sure it is secure.

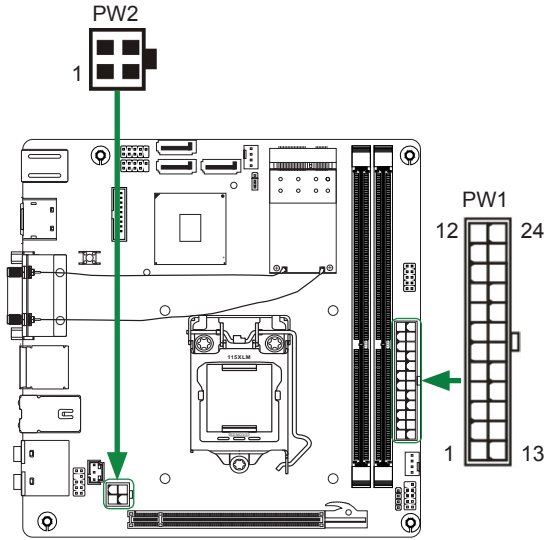

PW1-Pin Definition

Pin	Signal	Pin	Signal
1	+3.3V	13	+3.3V
2	+3.3V	14	-12V
3	GND	15	GND
4	+5V	16	PS_ON
5	GND	17	GND
6	+5V	18	GND
7	GND	19	GND
8	PWROK	20	-5V
9	+5V_AUX	21	+5V
10	+12V	22	+5V
11	+12V	23	+5V
12	+3.3V	24	GND

4-pin ATX_12V power connector-PW2

PW2, the 4-pin ATX 12V power connector, is used to provide power to the CPU. Align the pins to the connector and press firmly until seated.

PW2-Pin Definition

Pin	Signal
1	GND
2	GND
3	+12V
4	+12V

SPDIF-Out Header-CN5

This header provides a SPDIF (Sony/Philips Digital Interface) output to digital multimedia device through coaxial connector.

COM Header-CN4 (Optional)

CN4 - Pin Definition

Pin	Signal	Pin	Signal
1	DCD	2	RXD
3	TXD	4	DTR
5	GND	6	DSR
7	RTS	8	CTS
9	RI	10	NC

CN5 - Pin Definition

Pin	Signal
1	GND
2	SPDIF-out
3	VCC

Front panel header-FP1

The front panel header on this motherboard is one connector used to connect the following four cables :

FP1-Pin Definition

Pin	Signal	Pin	Signal
1	HDD_LED+	2	PW_LED+
3	HDD_LED-	4	PW_LED-
5	GND	6	PWR_SW
7	RESET	8	GND
9	NC	10	KEY

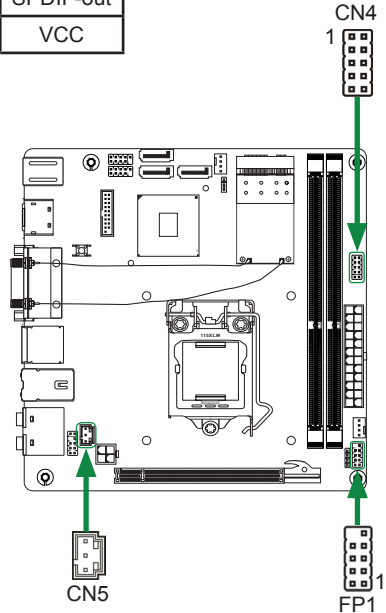

PWRLED

Attach the front panel power LED cable to these two pins of the connector. The Power LED indicates the system's status.

PWR SW

Attach the power button cable from the case to these two pins. Pressing the power button on the front panel turns the system on and off rather than using the power supply button.

HDD LED

Attach the hard disk drive indicator **LED** cable to these two pins. The HDD indicator **LED** indicates the activity status of the hard disks.

RST SW

Attach the Reset switch cable from the front panel of the case to these two pins. The system restarts when the **RESET** switch is pressed.

Note: Some chassis do not have all four cables. Be sure to match the name on the connectors to the corresponding pins.

USB Headers-FP_U1/2/FP_USB3_1

This motherboard contains four USB 2.0 and two USB 3.0 ports that are exposed on the rear panel of the chassis. The motherboard also contains two 10-pin internal USB 2.0 headers and one 20-pin USB 3.0 connector onboard.

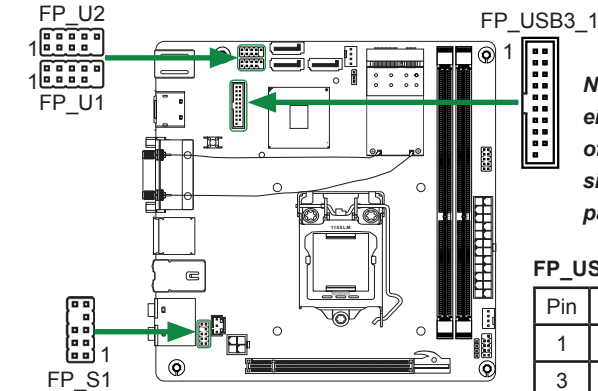

Note: Secure the bracket to either the front or rear panel of your chassis (not all chassis are equipped with the front panel option).

FP_U1~FP_U2-Pin Definition

PIN	Assignment	PIN	Assignment
1	VCC	2	VCC
3	USBP0-	4	USBP1-
5	USBP0+	6	USBP1+
7	GND	8	GND
9	KEY	10	NC

FP_USB3_1-Pin Definition

Pin	Signal	Pin	Signal
1	NC	2	BD+
3	AD+	4	BD-
5	AD-	6	GND2
7	GND1	8	BSSTX+
9	ASSTX+	10	BSSTX-
11	ASSTX-	12	GND3
13	GND	14	BSSRX+
15	ASSRX+	16	BSSRX-
17	ASSRX-	18	BVBUS
19	AVBUS	20	KEY

Front Panel Audio Header-FP_S1

The audio connector supports HD audio standard and provides two kinds of audio output choices: the Front Audio, the Rear Audio. The front Audio supports retasking function.

FP_S1-Pin Definition

PIN	Assignment	PIN	Assignment
1	MIC2(L)	2	GND
3	MIC(R)	4	-ACZ-DET
5	Front Audio(R)	6	Reserved
7	FAVDIO-JD	8	Key(No pin)
9	Front Audio(L)	10	Reserved

Note:

In order to utilize the front audio header, your chassis must have front audio connector. Also please make sure the pin assignment on the cable is the same as the pin assignment on the mainboard header. To find out if the chassis you are buying supports a front audio connector, please contact your dealer.

Speaker Header-SPK1

SPK1-Pin Definition

PIN	Assignment
1	VCC
2	NC
3	NC
4	SPK-

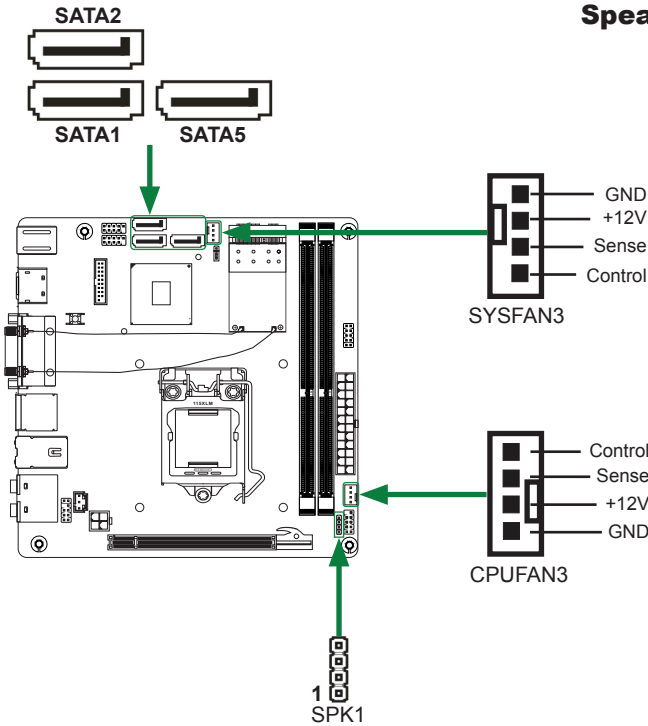

Serial-ATA (SATA) Connectors (SATA1/2/5)

The Serial ATA connector is used to connect the Serial ATA device to the motherboard. These connectors support the thin Serial ATA cables for primary storage devices. The motherboard incorporates three SATA II ports with maximum transfer rate up to 3.0 Gb/s each.

Fan Connectors

There are two fan connectors on the motherboard, including system fan connector-SYSFAN3 and CPU fan connector-CPUFAN3.

SATA-Pin Definition

Pin	Signal
1	GND
2	TXP
3	TXN
4	GND
5	RXN
6	RXP
7	GND

Expansion Slots

The motherboard contains two expansion slots, one Mini PCIe slot and one PCIe x16 slot.

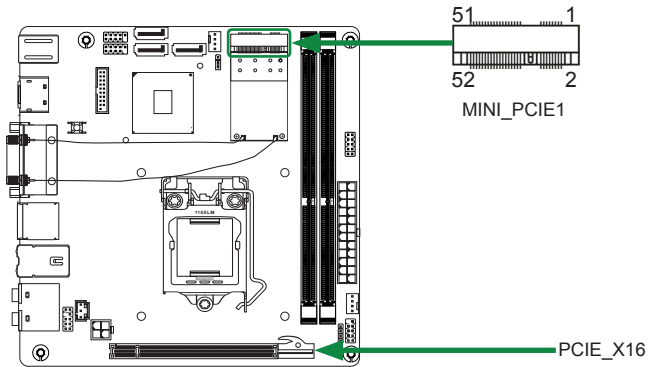

Mini PCI Express Slot-MINI_PCIE1

There is one Mini PCIe slot, reserved for the WiFi Module.



PCI Express x16 Slot-PCIE1

There is one PCIe x16 slot reserved for graphics card. It is fully compliant with PCIe 2.0 specification.

Jumper Settings

This section explains how to configure the motherboard's hardware. Before using your computer, make sure all jumpers and DRAM modules are set correctly. Refer to this section whenever in doubt.

CMOS Clear Jumper-JP1

JP1	Selection
1  1-2*	Normal*
1  2-3	CMOS Clear

 Close  Open * = Default setting.

If you want to clear the system configuration, use the JP1 (Clear CMOS Jumper) or SW1 (Clear CMOS Button) to clear data.

Notice:

1. Be sure to save the CMOS setting when exit the CMOS.
2. If the CPU is frequency multiplier locked, no CPU speed change will be seen even if the frequency multiplier setting in CMOS setup is changed.

Configuring the BIOS

This section discusses how to change the system settings through the BIOS Setup menus. Detailed descriptions of the BIOS parameters are also provided.

Enter BIOS Setup

The BIOS is the communication bridge between hardware and software. Correctly setting the BIOS parameters is critical to maintain optimal system performance.

Refer to the following procedure to verify/change BIOS settings.

1. Power on the computer.
2. Press the **Del** key when the following message briefly displays at the bottom of the screen during the Power On Self Test (POST).

Pressing **Del** takes you to the BIOS Setup Utility.

Note: 1. We reserve the right to update the BIOS version presented in the manual. The BIOS pictures shown in this section are for reference only.

2. It is strongly recommended that you do not change the default BIOS settings. Changing some settings could damage your system.

Main Menu

This menu gives you an overview of the general system specifications. The BIOS automatically detects the items in this menu.

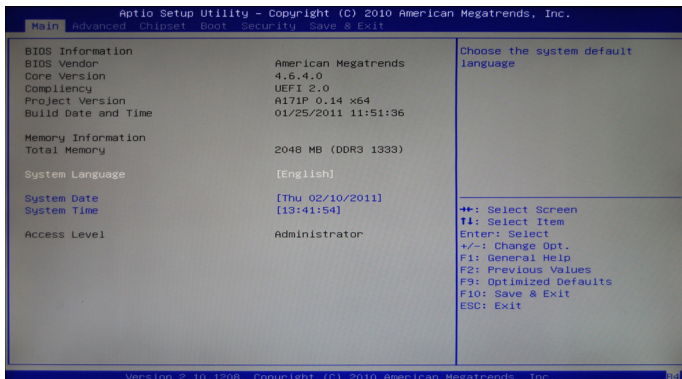

Note: Users please note that the data in gray is non-changeable, and the others are for selection.

- BIOS Information**
Displays the auto-detected BIOS information.
- Memory Information**
Displays the auto-detected memory information.
- System Language**
Choose the system default language.
- System Date/Time**
Allows you to set the system date/time.

Advanced Menu

The Advanced menu items allow you to change the setting for the CPU and other system devices. Press <enter> to display the configuration options:

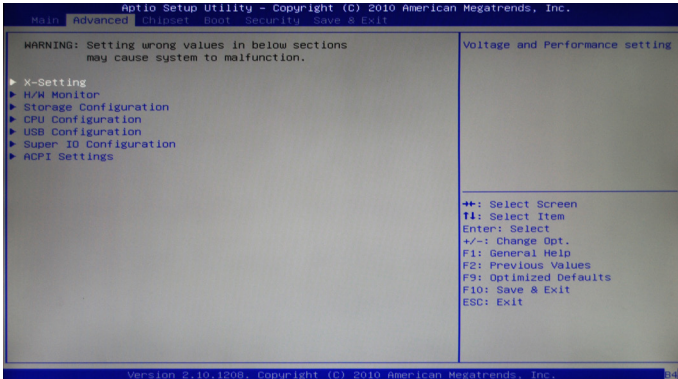

X-Setting

The X-Setting menu items show the settings of CPU, memory and so on.

- CPU Performance**
Use this item to adjust CPU performance.
- GPU Boost**
Use this item to adjust graphics configuration.
- Memory Timing Configuration**
Use this item to adjust memory timing configuration.
- Adjust Memory Voltage**
Use this item to adjust memory voltage.
- Adjust PCH Voltage**
Use this item to adjust PCH voltage.

H/W Monitor

The items in this menu allow you to monitor the hardware status. Press <enter> to display the configuration options:

- CPU FAN Control Mode**
Use this item to select CPU FAN Control mode.
- Start Temperature**
Use this item to select the start temperature.
- Start Fan Duty**
Use this item to select the start fan duty.
- Highest Fan Duty**
Use this item to select the highest fan duty.

Storage Configuration

The items in this menu allow you to set or change the storage configurations. Press <enter> to display the configuration options:

SATA Mode

Allows you to choose SATA mode, including [Disabled], [IDE Mode], and [AHCI Mode].

Serial-ATA Controller 0/1

Allows you to configure SATA controller.

CPU Configuration

The items in this menu show the CPU-related information that the BIOS automatically detects. Press <enter> to display the configuration options:

Hyper-threading

This item allows you to enable or disable Intel® Hyper-Threading technology support.

Active Processor Cores

This item allows you to choose the number of the active processor cores. The default value is [All].

Limit CPUID Maximum

Allows you to determine whether to limit CPUID maximum value. Set this item to [Disable] Windows XP operating system; set this item to [Enable] for legacy operating system such as Windows NT4.0..

Execute Disable Bit

When disabled forces the XD feature flag to always return 0, defaults choose [Enable].

Hardware Prefetcher

Use this item to enable or disable hardware prefetcher (hardware prefetch mechanism).

Adjacent Cache Line Prefetch

Use this item to enable or disable the adjacent cache line prefetch mode. If you disable this item, only one 64-bit line will be prefetched from the 128-bit section (including the required data). If you enable this item, two lines will be prefetched whether there is required data or not.

Intel Virtualization Technology

Hardware Virtualization Technology enables processor feature for running multiple simultaneous virtual machines allowing specialized software applications to run in full isolation of each other.

Power Technology

Use this option to set Power Technology.

USB Configuration

The items in this menu allow you to change the USB-related features. Press <enter> to display the configuration options:

Legacy USB Support

Allows you to enable or disable support for USB devices on legacy operating systems.

EHCI Hand-Off

Allows you to enable support for operating systems without an EHCI hand-off feature.

 USB transfer time-out

Allows you to set USB transfer time-out.

 Device reset time-out

Allows you to set device reset time-out.

 Device power-up delay

Allows you to set device power-up delay.

Super IO Configuration

The items in this menu allow you to configure NCT5577D Super IO Chipset.

 Serial Port 0 Configuration

Allows you to set parameters of Serial Port 0 (COMA).

ACPI Settings

The items in this menu allow you to set ACPI Configuration.

 ACPI Sleep State

Select the highest ACPI sleep state, the system will enter when the SUSPEND button is pressed.

 Restore on AC Power Loss

This item allows you to configure how the system board responds to a power failure.

 Deep Sleep

When enabled, wake up from S4/S5 can only be done by power button.

Chipset Menu

The chipset menu items allow you to change the advanced chipset settings. Press <enter> to display the sub-menu:

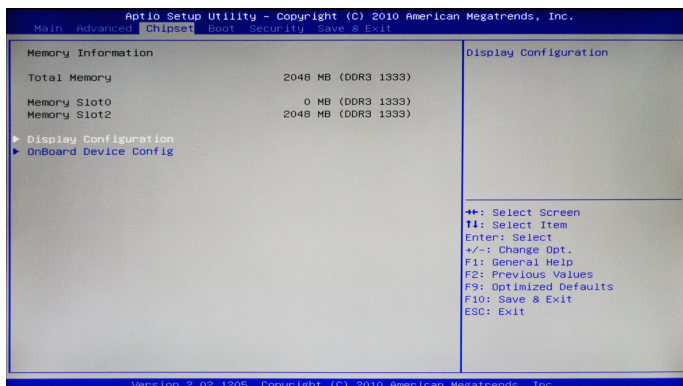
**Display Configuration**

The item allows you to configure north bridge features, including Memory, Graphics, and so on.

OnBoard Device Config

The item allows you to configure onboard device features, including HDA, HDMI, and so on.

Boot Menu

The Boot menu items allow you to change the system boot options. Press <enter> to display the configuration options:

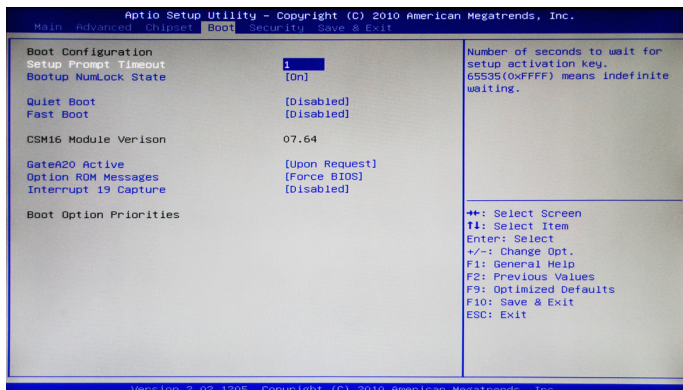

Boot Settings Configuration

The items allow you to configure Boot settings. Press <enter> To display the configuration options:

Setup Prompt Timeout

Use this item to set number of seconds to wait for setup activation key.

Bootup NumLock State

Use this item to select the keyboard NumLock state: [On] or [Off].

Quiet Boot

When set to [Disabled], displays normal POST message. When set to [Enabled], displays OEM Logo instead of POST messages.

Fast Boot

Enable or disable boot with initialization of a minimal set of devices required to launch active boot option.

GateA20 Active

When set to [Upon Request], GA20 can be disabled using BIOS services. When set to [Always], GA20 can not be disabled; this option is useful when any RT code is executed above 1MB.

Option ROM Messages

Use this item to set display mode for Option.

☐ Interrupt 19 Capture

When set to [Enabled], this function allows the option ROMs to trap interrupt 19.

Security Menu

The security menu items allow you to change the system security settings. Press <enter> to display the configuration options:

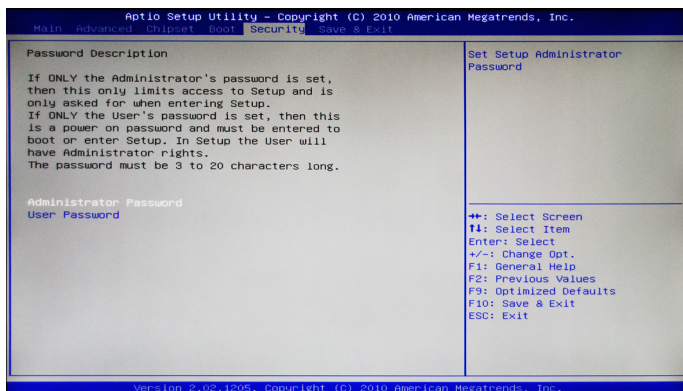

Administrator Password

Select this item to set Setup Administrator Password.

User Password

Select this item to set the user password.

To set an Administrator/User Password:

1. Select the item [Administrator/User Password] and press <Enter>.
2. From the password box, type a password composed of at least six letters and/or numbers, then press <Enter>.
3. Confirm the password when prompted:

The message "Password Installed" appears after you successfully set your password.

To change the administrator/user password, follow the same steps as setting a user password.

To clear the administrator/user password, select the item [Administrator/User password], then press <enter>. The message "Password Uninstalled" appears.

Exit Menu

The exit menu items allow you to load the option or failsafe default values for the BIOS items, and save or discard your changes to the BIOS items. Press <enter> to display the sub-menu:

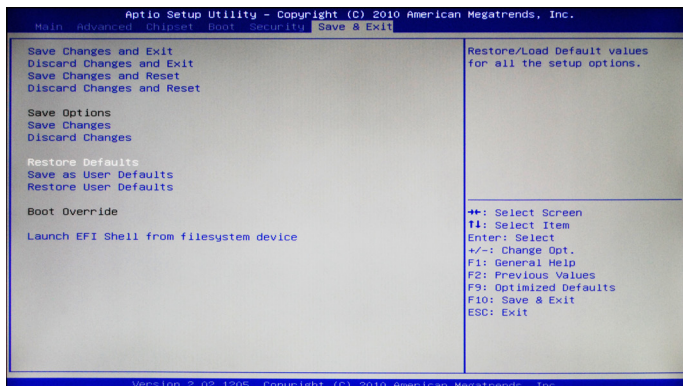

Save Changes and Exit

Select this item and press <Enter> to save the changes that you have made in the BIOS Setup and exit the BIOS Setup. When the dialog box [Save configuration and exit?] appears, select [Yes] to save and exit, or select [No] to return to the main menu.

Discard Changes and Exit

Select this option only if you do not want to save the changes that you have made to the setup program. If you made changes to fields other than system date, system time, and password, the BIOS asks for a confirmation before exiting.

Save Changes and Reset

Select this item and press <Enter> to reset the system after saving the changes. When the dialog box [Save configuration and reset?] appears, select [Yes] to save and reset, or select [No] to return to the main menu.

Discard Changes and Reset

Select this item and press <Enter> to reset system setup without saving any changes. When the dialog box [Reset without saving?] appears, select [Yes] to discard and reset, or select [No] to return to the main menu.

Save Changes

Select this item and press <Enter> to save the changes that you have made in the BIOS Setup and exit the BIOS Setup. When the dialog box [Save configuration?] appears, select [Yes] to save changes, or select [No] to return to the main menu.

Discard Changes

This option allows you to discard the selections you have made and restore the previously saved values. When the dialog box [Load Previous Values?] appears, select [Yes] to discard any change and load the previously saved values.

Restore Defaults

Use this item to restore/load default values for all the setup options.

Save as User Defaults

Use this item to save the changes as User Defaults.

Restore User Defaults

Use this item to restore the User Defaults to all the setup options.

Launch EFI Shell from filesystem device

Use this item to launch EFI Shell application (Shellx64.efi) from one of the available filesystem devices.

FLASH Update Procedure

The program EFUDOS.exe is included in the driver CD (X:\Utility\EFUDOS.exe). Please follow the recommended procedure to update the flash BIOS, as listed below.

(X: your CD driver letter).

1. Create a DOS-bootable floppy diskette. Copy the new BIOS file (just obtained or downloaded) and the utility program EFUDOS.exe to the diskette.
2. Allow the PC system to boot from the DOS diskette.
3. At the DOS prompt, type

EFUDOS XX.ROM /P /B /N <ENTER>

Note: XX (the BIOS file name) can be defined by users.

4. Wait until the flash-update is complete.
5. Restart the PC.

<p>Warning: - Do not turn off or RESET the computer during the flash process. - If you are not sure how to upgrade the BIOS, please take your computer to an Authorized Service Center and have a trained technician do the work for you.</p>
--

Installing Drivers and Software

Note: It is important to remember that before installing the driver CD that is shipped in the kit, you need to load your operating system. The motherboard supports Windows XP 32 bit/64 bit, Windows Vista 32 bit/64 bit and Windows 7 32bit/64bit.

The kit comes with a CD that contains utility drivers and additional INTEL software.

The CD that has been shipped with your Intel® H67 motherboard contains the following software and drivers:

- Intel Chipset Driver
- HDA Sound Driver
- Intel Graphics Driver
- Ethernet PCI-E Driver
- USB 3.0 Controller Driver
- Atheros Wireless Driver
- Intel Management Engine

Note. We reserve the right to update the driver version presented in the manual. The driver installation pictures shown in this section are for reference only.

Drivers Installation

1. Insert the Intel® H67 driver CD into the drive after loading your operating system, and then you can see the interface below.



2. Left-click **Intel Chipset Driver**, begin loading





3. Left-click **HDA Sound Driver**, begin loading

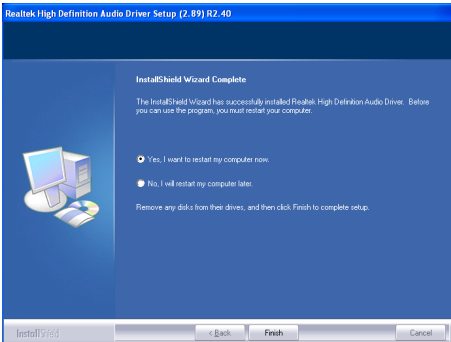
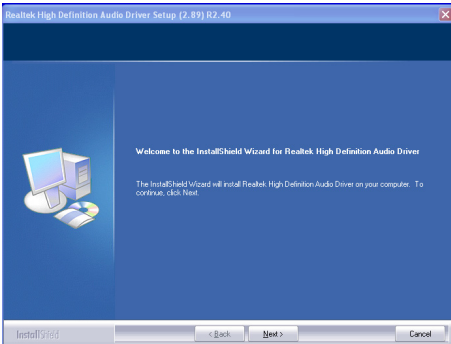

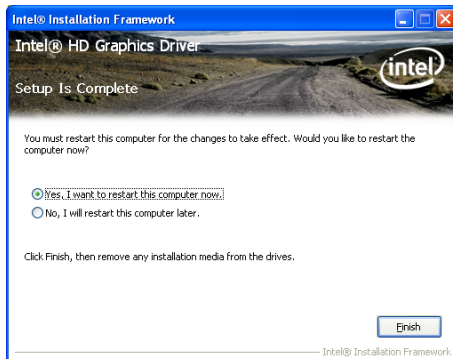
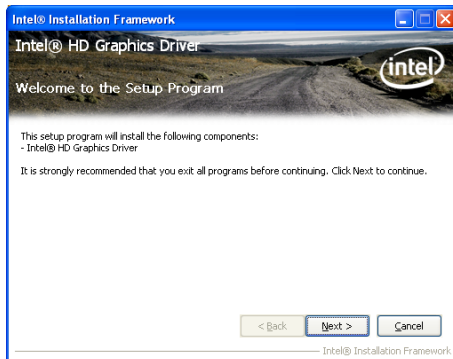
4. Left-click **Intel Graphics Driver**, begin loading

5. Left-click **Ethernet PCI-E Driver**, begin loading

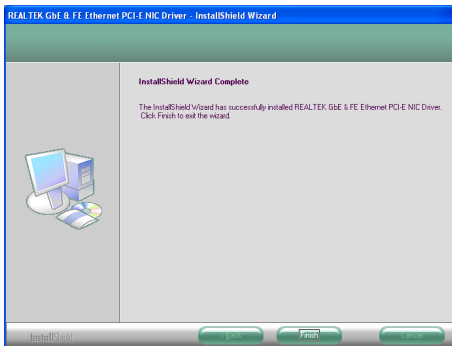
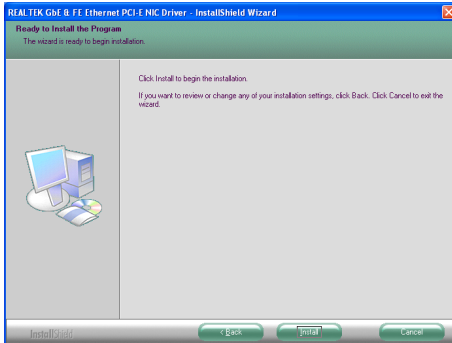
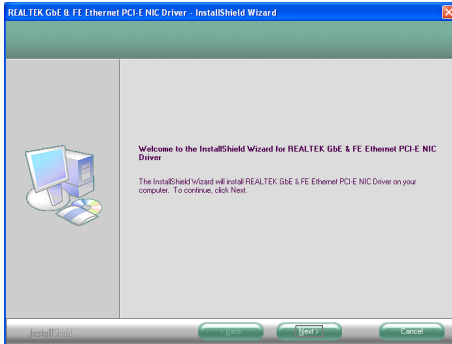

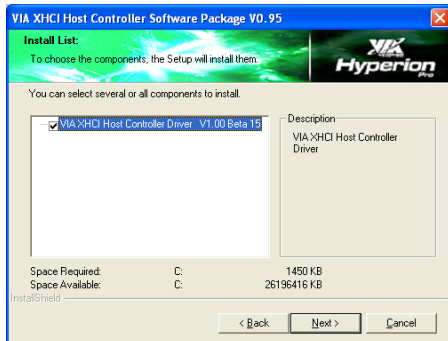
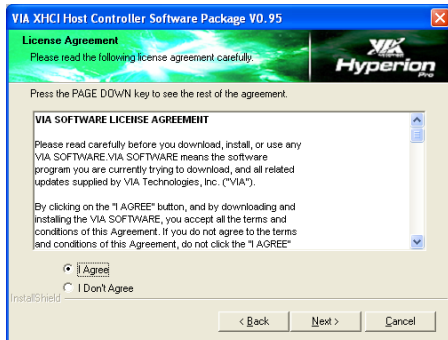
6. Left-click **USB 3.0 Controller Driver**, begin loading

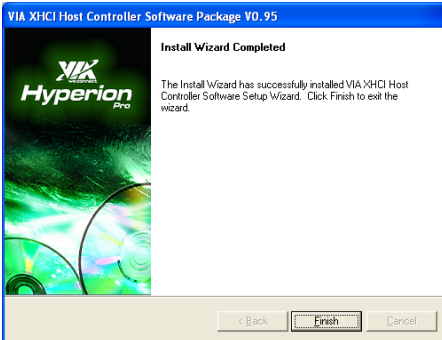
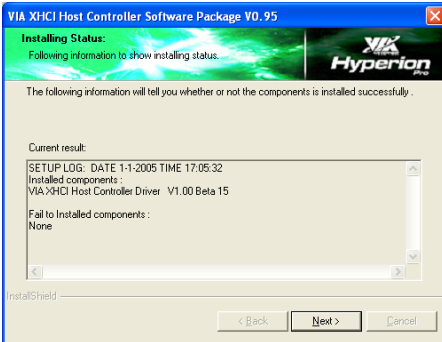
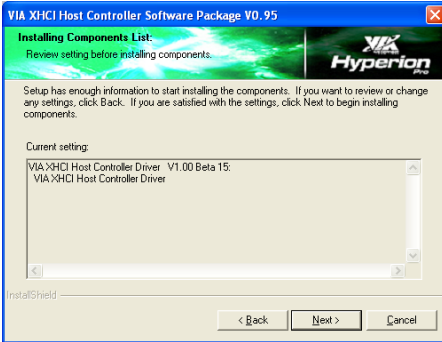

Note: USB 3.0 port would not work in POST, CMOS setup and DOS mode.

7. Left-click **Atheros Wireless driver**, begin loading

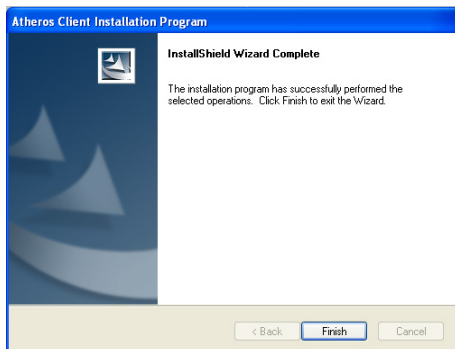
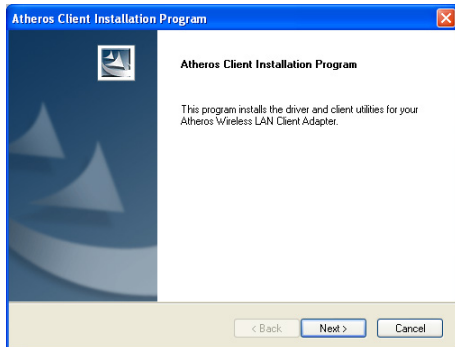

8. Left-click **Intel Management Engine**, begin loading

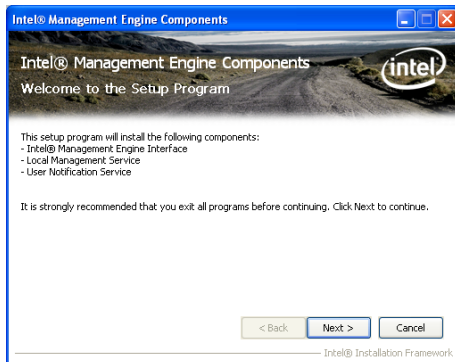

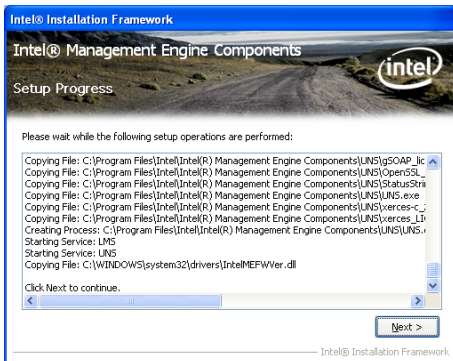
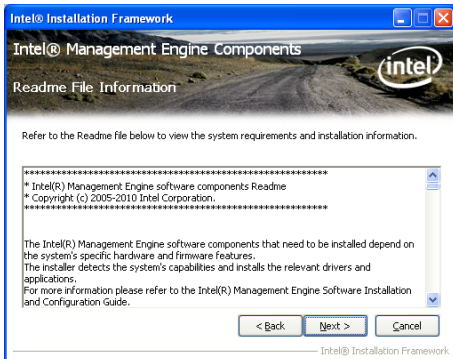

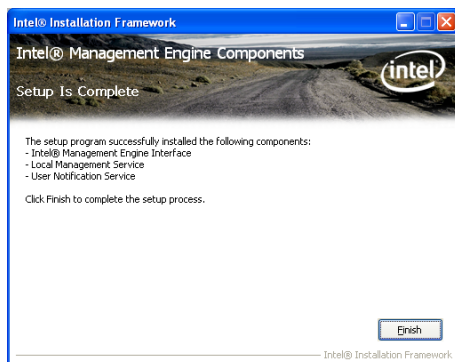

At last, you can enter Computer Management that provides information about the hardware devices on this motherboard to check if the driver installation is complete.

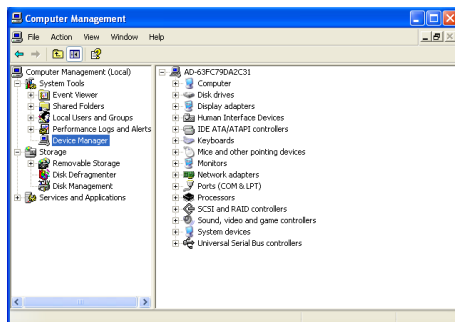

Realtek HD Audio Driver Setup Getting Started

After Realtek HD Audio Driver being installed (insert the driver CD and follow the on-screen instructions), “Realtek HD Audio Manager” icon will show in System tray as below. Double click the icon and the control panel will appear:



Sound Effect

After clicking on the “Sound Effect” tab, 3 sections “Environment”, “Equalizer” and “Karaoke” are available for selection.



Environment Simulation

You will be able to enjoy different sound experience by pulling down the arrow, totally 23 kinds of sound effect will be shown for selection. Realtek HD Audio Sound Manager also provides five popular settings “Stone Corridor”, “Bathroom”, “Sewer pipe”, “Arena” and “Audio Corridor” for quick enjoyment.

Equalizer Selection

The Equalizer section allows you to create your own preferred settings by utilizing this tool.

In standard 10 bands of equalizer, ranging from 100Hz to 16KHz are available:

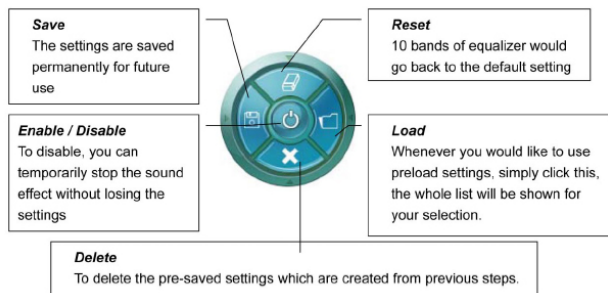

Frequently Used Equalizer Setting

Realtek recognizes the needs that you might have. By leveraging our long experience at audio field, Realtek HD Audio Sound Manager provides you certain optimized equalizer settings that are frequently used for your quick enjoyment.

How to Use

Other than the buttons “Pop” “Live” “Club” & “Rock” shown on the page, to pull down the arrow in “Others” , you will find more optimized settings available to you.

Karaoke Mode

Karaoke mode brings Karaoke fun back home by simply using the music you usually play, Karaoke mode can help you eliminate the vocal of the song or adjust the key to accommodate your range.

Vocal Cancellation: Single click on “Voice Cancellation”, the vocals of the songs will be erased, while the background music is still playing which lets you take over the vocal part.

Key Adjustment: Using “Up/Down Arrow” to find a key which better fits your vocal range.

Mixer

Realtek HD Audio Sound Manager integrates Microsoft's "Volume Control" functions into the Mixer page. This gives you the advantage to you to create your favorite sound effect in one single tool.

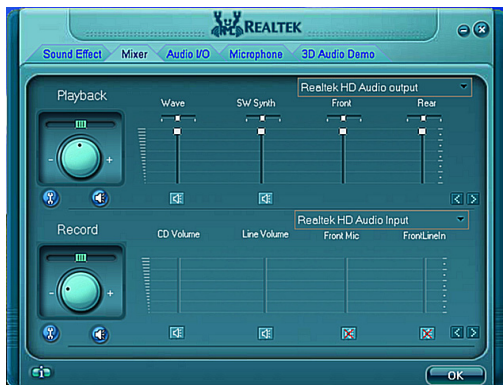

Playback control

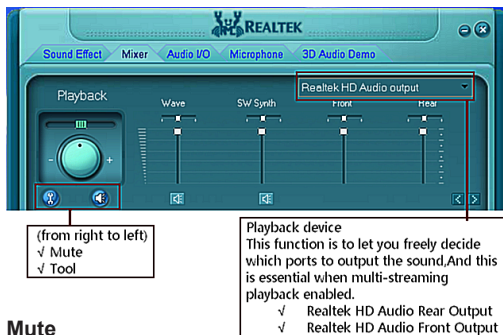

Mute

You may choose to mute single or multiple volume controls or to completely mute sound output.

Tool

✓ Show the following volume control

This is to let you freely decide which volume control items to be displayed, total 13 items to be chosen.

✓ Advanced controls

✓ Enable playback multi-streaming

With this function, you will be able to have an audio chat with your friends via headphone (stream 1 from front panel) while still have music (stream 2 from back panel) playing. At any given period, you can have maximum 2 streams operating simultaneously.

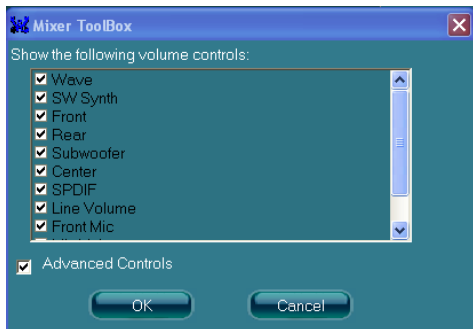

Recording control

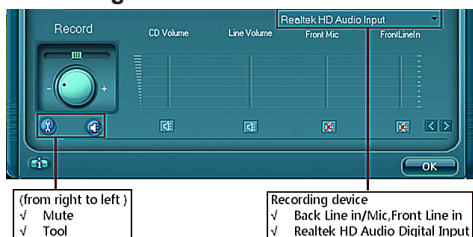

Mute

You may choose to mute single or multiple volume controls or to completely mute sound input.

Tool

✓ Show the following volume controls

This is to let you freely decide which volume control items to be displayed.

✓ Advanced controls.

Advanced control is a “Microphone Boost” icon.

Once this item is checked, you will find “advanced” icon beside “Front Pink In” & “Mic Volume”. With this, the input signal into “Front Pink In” & “Mic Volume” will be strengthen.

✓ Enable recording multi-streaming

At any given period, you can have maximum 2 streams operating simultaneously.

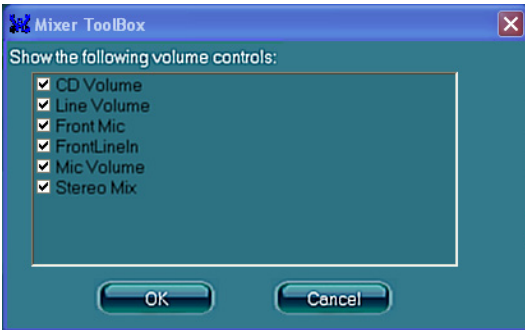

Audio I/O

Realtek HD Audio Manager frees you from default speaker settings. Different from before, for each jack, they are not limited to perform certain functions. Instead, now each jack is able to be chosen to perform either output (i.e. playback) function or input (i.e. Recording) function, we call this “Retasking”.

Audio I/O aims to help you setting jacks as you wish. Moreover, other than blue to blue, pink to pink, the way that you used to do, Audio I/O would guide you to other right jacks that can also serve as microphone / speaker / headphone.



Speaker Configuration

Step 1: Plug in the device in any available jack.

Step 2: Dialogue “Connected device” will pop up for your selection. Please select the device you are trying to plug in.

* If the device is being plugged into the correct jack, you will be able to find the icon beside the jack changed to the one that is same as your device.

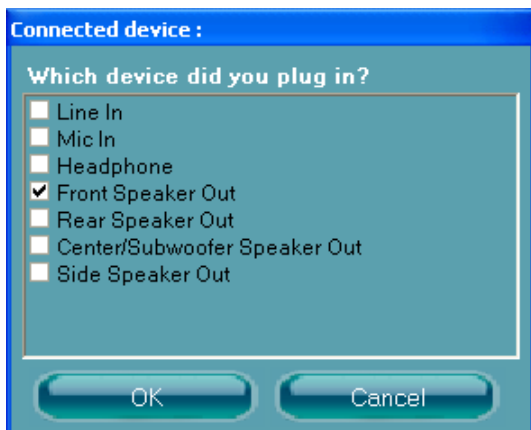

Connector Settings

Click  to access connector settings

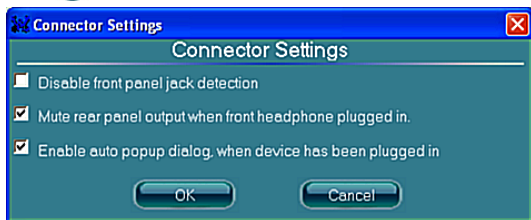

- ✓ **Mute rear panel when front headphone plugged in**
Once this option is checked, when front headphone is plugged, the music that is playing from the back panel, will be stopped.
- ✓ **Disable front panel jack detection (option)**
Did not find any function on front panel jacks?
Please check if front jacks on your system are so-called AC'97 jacks. If so, please check this item to disable front panel jack detection.
- ✓ **Enable auto popup dialogue, when device has been plugged in.**
Once this item checked, the dialog "Connected device" would automatically pop up when device plugged in.

S/PDIF

Short for **S**ony/**P**hilips **D**igital **I**nterface, a standard audio file transfer format. S/PDIF allows the transfer of digital audio signals from one device to another without having to be converted first to an analog format. Maintaining the viability of a digital signal prevents the quality of the signal from degrading when it is converted to analog.

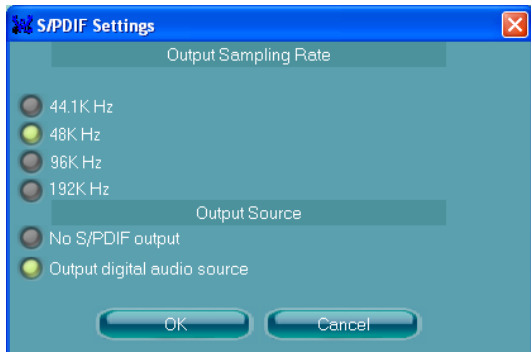

√ Output Sampling Rate

- 44.1KHz: This is recommended while playing CD
- 48KHz: This is recommended while playing DVD or Dolby
- 96KHz: This is recommended while playing DVD-Audio
- 192KHz: This is recommended while playing HD Audio

√ Output Source

- Output digital audio source: The digital audio format (such as .wav, .mp3, .midi etc) will come out through S/PDIF-Out.

Speaker Calibration

After you have successfully plugged in speakers and assigned to the right jacks, you are only one more step to go to enjoy the intended sound. We provide "Speaker Calibration" to help you check if the speakers are located in the correct position.

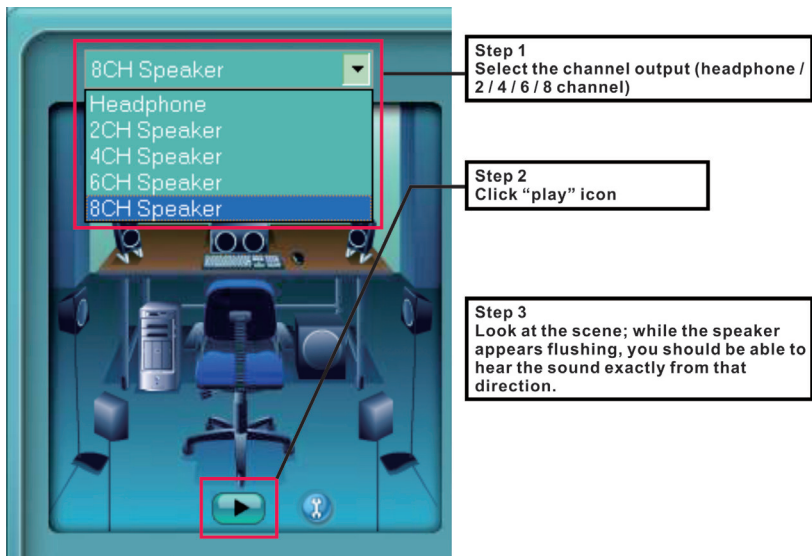

Microphone

This page is designed to provide you better microphone/recording quality.

Below picture indicates both “Noise Suppression” & “Acoustic Echo Cancellation” are both enabled.



Noise Suppression

If you feel that the background noise, especially the sound generated from the fan inside PC, is too loud? Try “Noise Suppression”, which allows you to cut off and suppress disturbing noise.

Beam Forming

Also known as “directional recording”, this option lets you do the following: Once beam forming is enabled; only the sound from certain direction will be recorded. You will get the best quality if you chose 90° position, which we recommend you to use, this effectively means that you speak right into the microphone.

Note: A Stereo Microphone is required when using Beam Forming function.

Acoustic Echo Cancellation

This function prevents playback sound from being recorded by microphone together with your sound. For example, you might have chance to use VOIP function through Internet with your friends. The voice of your friend will come out from speakers (playback). However, the voice of your friend might also be recorded into your microphone then go back to your friend through Internet. In that case, your friend will hear his/her own voice again. With AEC (Acoustic Echo Cancellation) enabled at your side, your friend can enjoy the benefit with less echo.

3D Audio Demo

The section “3D Audio Demo” grants you another possibility to enjoy your sound. The Audio Demo allows you to listen to sound in an extraordinary way.



Information

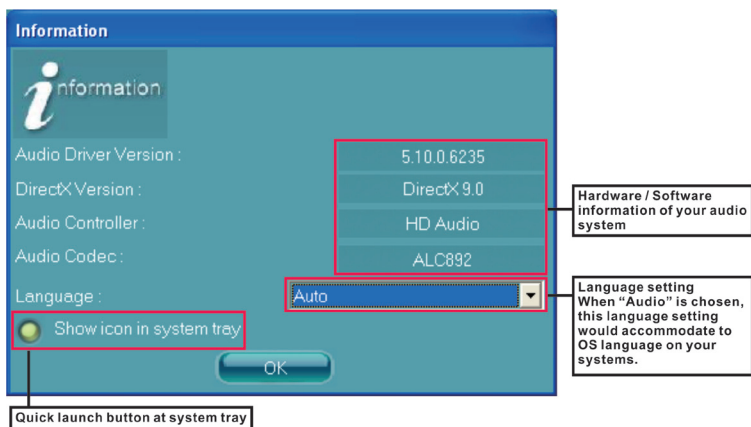

This section provides information about your current system audio device.

ZOTAC[®]
It's Time to Play

WWW.ZOTAC.COM

